

Parker Legris connectic

products are available from

MARYLAND METRICS

P.O. Box 261 Owings Mills, MD 21117 USA

ph: (410)358-3130 (800)638-1830

fx: (410)358-3142 (800)872-9329

email: sales@mdmetric.com web: <http://mdmetric.com>

RFQ form: <http://mdmetric.com/rfq.htm>



pneumatic function fittings



blocking fittings

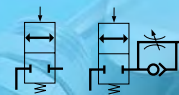

with push-in connection

7880 BSP parallel

ØD	C	
6	G1/8	7880 06 10
6	G1/4	7880 06 13
8	G1/4	7880 08 13
8	G3/8	7880 08 17
10	G3/8	7880 10 17
12	G1/2	7880 12 21

7885 BSP taper

ØD	C	
6	R1/8	7885 06 10
6	R1/4	7885 06 13
8	R1/4	7885 08 13
8	R3/8	7885 08 17
10	R3/8	7885 10 17
12	R1/2	7885 12 21

7885 NPT

ØD	C	
1/4	1/8	7885 56 11
1/4	1/4	7885 56 14
3/8	3/8	7885 60 18
1/2	1/2	7885 62 22

7883 with flow regulator and instant fitting
BSP parallel

ØD	C	
4	G1/8	7883 04 10
6	G1/8	7883 06 10
6	G1/4	7883 06 13
8	G1/4	7883 08 13

with threaded connection

7881 BSP parallel

C1	C2	
G1/4	G1/8	7881 13 10
G1/4	G1/4	7881 13 13
G3/8	G3/8	7881 17 17
G1/2	G1/2	7881 21 21

7886 BSP taper

C1	C2	
R1/4	R1/8	7886 13 10
R1/4	R1/4	7886 13 13
R3/8	R3/8	7886 17 17
R1/2	R1/2	7886 21 21

7886 NPT

C1	C2	
1/8	1/8	7886 11 11
1/4	1/4	7886 14 14
3/8	3/8	7886 18 18
1/2	1/2	7886 22 22

Visual identification of different threads

- 7880 06 13 = BSP parallel
- 7885 06 13 = BSP taper
- 7885 56 14 = NPT

non-return valves



in-line

7996 for metric tube

ØD	
4	7996 04 00
6	7996 06 00
8	7996 08 00
10	7996 10 00
12	7996 12 00

for inch tube

ØD	
5/32	7996 04 00
1/4	7996 56 00
5/16	7996 08 00
3/8	7996 60 00

with threaded connection

7984-7994 BSP parallel and metric

ØD	C	exhaust flow	supply flow
4	M5x0,8	7994 04 19	7984 04 19
4	G1/8	7994 04 10	7984 04 10
6	G1/8	7994 06 10	7984 06 10
6	G1/4	7994 06 13	7984 06 13
8	G1/8	7994 08 10	7984 08 10
8	G1/4	7994 08 13	7984 08 13
10	G3/8	7994 10 17	7984 10 17
12	G3/8	7994 12 17	7984 12 17
12	G1/2	7994 12 21	7984 12 21

7985-7995 BSP taper

ØD	C	exhaust flow	supply flow
4	R1/8	7995 04 10	7985 04 10
6	R1/8	7995 06 10	7985 06 10
6	R1/4	7995 06 13	7985 06 13
8	R1/8	7995 08 10	7985 08 10
8	R1/4	7995 08 13	7985 08 13
10	R3/8	7995 10 17	7985 10 17
12	R3/8	7995 12 17	7985 12 17
12	R1/2	7995 12 21	7985 12 21

7984-7994-7985-7995 NPT and UNF

ØD	C	exhaust flow	supply flow
5/32	10-32	7994 04 20	7984 04 20
5/32	1/8	7995 04 11	7985 04 11
1/4	1/8	7995 56 11	7985 56 11
1/4	1/4	7995 56 14	7985 56 14
3/8	1/4	7995 60 14	7985 60 14
3/8	3/8	7995 60 18	7985 60 18

flow control regulators – polymer version

miniature

7660-7662-7669

BSP parallel and metric

ØD	C	Exhaust (A)	Supply (B)	Bi-directional (C)
3	M3x0,5	7660 03 09	7669 03 09	
3	M5x0,8	7660 03 19	7669 03 19	
4	M3x0,5	7660 04 09		
4	M5x0,8	7660 04 19	7669 04 19	7662 04 19
4	G1/8	7660 04 10	7669 04 10	7662 04 10
6	M5x0,8	7660 06 19	7669 06 19	7662 06 19
6	G1/8	7660 06 10	7669 06 10	7662 06 10
6	G1/4	7660 06 13	7669 06 13	7662 06 13
8	G1/8	7660 08 10	7669 08 10	
8	G1/4	7660 08 13	7669 08 13	
8	G3/8	7660 08 17	7669 08 17	

7665-7668

BSP taper

ØD	C	Exhaust (A)	Supply (B)
4	R1/8	7665 04 10	7668 04 10
6	R1/8	7665 06 10	7668 06 10
6	R1/4	7665 06 13	7668 06 13
6	R3/8	7665 06 17	
8	R1/8	7665 08 10	7668 08 10
8	R1/4	7665 08 13	7668 08 13
8	R3/8	7665 08 17	7668 08 17

7660-7665-7668-7669 UNF and NPT

ØD	C	Exhaust (A)	Supply (B)
1/8	10-32	7660 53 20	7669 53 20
1/8	1/8	7665 53 11	
5/32	10-32	7660 04 20	7669 04 20
5/32	1/8	7665 04 11	7668 04 11
1/4	10-32	7660 56 20	7669 56 20
1/4	1/8	7665 56 11	7668 56 11
1/4	1/4	7665 56 14	7668 56 14

7630-7631

plug-in, for metric tube

ØD	Exhaust (A)	Supply (B)
4	7630 04 00	7631 04 00
6	7630 06 00	7631 06 00

plug-in, for inch tube

ØD	Exhaust (A)	Supply (B)
1/8	7630 53 00	7631 53 00
1/4	7630 56 00	7631 56 00

7640-7649

swivel outlet, BSP parallel and metric

ØD	C	Exhaust (A)	Supply (B)
4	M5x0,8	7640 04 19	7649 04 19
4	G1/8	7640 04 10	7649 04 10
6	M5x0,8	7640 06 19	7649 06 19
6	G1/8	7640 06 10	7649 06 10

7645

swivel outlet, BSP taper

ØD	C	Exhaust (A)
4	R1/8	7645 04 10
6	R1/8	7645 06 10

7640-7645

swivel outlet, UNF and NPT

ØD	C	Exhaust (A)
5/32	10-32	7640 04 20
5/32	1/8	7645 04 11

compact

7060-7061-7062

BSP parallel

ØD	C	Exhaust (A)	Supply (B)	Bi-directional (C)
4	G1/8	7060 04 10	7061 04 10	7062 04 10
6	G1/8	7060 06 10	7061 06 10	7062 06 10
6	G1/4	7060 06 13	7061 06 13	7062 06 13
8	G1/8	7060 08 10	7061 08 10	7062 08 10
8	G1/4	7060 08 13	7061 08 13	7062 08 13
8	G3/8	7060 08 17	7061 08 17	7062 08 17
10	G1/4	7060 10 13	7061 10 13	
10	G3/8	7060 10 17	7061 10 17	
12	G3/8	7060 12 17		
12	G1/2	7060 12 21	7061 12 21	

7065-7066-7067

BSP taper

ØD	C	Exhaust (A)	Supply (B)	Bi-directional (C)
4	R1/8			7067 04 10
6	R1/8	7065 06 10		7067 06 10
6	R1/4			7067 06 13
8	R1/8	7065 08 10		7067 08 10
8	R1/4	7065 08 13		7067 08 13
8	R3/8			7067 08 17
10	R1/4	7065 10 13	7066 10 13	
10	R3/8	7065 10 17	7066 10 17	
10	R1/2	7065 10 21	7066 10 21	
12	R1/4	7065 12 13	7066 12 13	
12	R3/8	7065 12 17	7066 12 17	
12	R1/2	7065 12 21	7066 12 21	

7065-7066-7067

NPT

ØD	C	Exhaust (A)	Supply (B)	Bi-directional (C)
5/32	1/8	7065 04 11	7066 04 11	7067 04 11
5/32	1/4	7065 04 14	7066 04 14	
1/4	1/8	7065 56 11	7066 56 11	7067 56 11
1/4	1/4	7065 56 14	7066 56 14	7067 56 14
3/8	1/4	7065 60 14		
3/8	3/8	7065 60 18		

7030-7031

plug-in, metric tube

ØD	Exhaust (A)	Supply (B)
6	7030 06 00	7031 06 00
8	7030 08 00	7031 08 00
10	7030 10 00	7031 10 00
12	7030 12 00	7031 12 00

7040-7041

swivel outlet, BSP parallel

ØD	C	Exhaust (A)	Supply (B)
6	G1/8	7040 06 10	
6	G1/4	7040 06 13	7041 06 13
8	G1/8	7040 08 10	7041 08 10
8	G1/4	7040 08 13	7041 08 13
8	G3/8	7040 08 17	
10	G1/4	7040 10 13	
10	G3/8	7040 10 17	
12	G3/8	7040 12 17	
12	G1/2	7040 12 21	

7045

swivel outlet, BSP taper

ØD	C	Exhaust (A)
6	R1/4	7045 06 13
8	R1/8	7045 08 10
8	R1/4	7045 08 13
8	R3/8	7045 08 17
10	R1/4	7045 10 13
10	R3/8	7045 10 17
12	R3/8	7045 12 17
12	R1/2	7045 12 21

7045

swivel outlet, NPT

ØD	C	Exhaust (A)
1/4	1/8	7045 56 11
1/4	1/4	7045 56 14
3/8	1/4	7045 60 14
3/8	3/8	7045 60 18

Visual identification of different threads

7660 06 10	= BSP parallel
7665 06 10	= BSP taper
7665 56 11	= NPT

flow control regulators – polymer version

with recessed screw

7010-7011-7012

BSP parallel and metric

ØD	C	Exhaust (A)	Supply (B)	Bi-directional (C)
4	M5x0,8	7010 04 19	7011 04 19	7012 04 19
4	G1/8	7010 04 10	7011 04 10	7012 04 10
6	M5x0,8	7010 06 19	7011 06 19	7012 06 19
6	G1/8	7010 06 10	7011 06 10	7012 06 10
6	G1/4	7010 06 13	7011 06 13	7012 06 13
8	G1/8	7010 08 10	7011 08 10	7012 08 10
8	G1/4	7010 08 13	7011 08 13	7012 08 13
8	G3/8	7010 08 17	7011 08 17	7012 08 17
10	G1/4	7010 10 13	7011 10 13	
10	G3/8	7010 10 17	7011 10 17	
10	G1/2	7010 10 21		
12	G3/8	7010 12 17		
12	G1/2	7010 12 21		

in-line

7771

with threaded fitting, BSP parallel

C	One-way
G1/8	7771 10 10
G1/4	7771 13 13
G3/8	7771 17 17
G1/2	7771 21 21

in-line

7770-7772

for metric tube

ØD	One-way	Bi-directional
4	7770 04 00	7772 04 00
6	7770 06 00	7772 06 00
8	7770 08 00	7772 08 00
10	7770 10 00	
12	7770 12 00	

for inch tube

ØD	One-way	Bi-directional
5/32	7770 04 00	7772 04 00
1/4	7770 56 00	7772 56 00
5/16	7770 08 00	7772 08 00
3/8	7770 60 00	
1/2	7770 62 00	

7776

bulkhead, for metric tube

ØD	One-way
4	7776 04 00
6	7776 06 00
8	7776 08 00
10	7776 10 00
12	7776 12 00

manual operated valves



7800-7801

3/2 manual switch operated valves, with push-in connection, BSP parallel

ØD	C	Supply	Control
4	M5x0,8	7800 04 19	
4	G1/8	7800 04 10	7801 04 10
6	M5x0,8	7800 06 19	
6	G1/8	7800 06 10	7801 06 10
6	G1/4	7800 06 13	7801 06 13
8	G1/8	7800 08 10	7801 08 10
8	G1/4	7800 08 13	7801 08 13
10	G1/4	7800 10 13	7801 10 13

7805-7806

3/2 manual switch operated valves, with push-in connection, NPT

ØD	C	Supply	Control
5/32	1/8	7805 04 11	7806 04 11
1/4	1/8	7805 56 11	7806 56 11
1/4	1/4	7805 56 14	7806 56 14
3/8	1/4	7805 60 14	7806 60 14

7802

2/2 manual switch operated valve, with push-in connection, BSP parallel

ØD	C	Supply
4	G1/8	7802 04 10
6	G1/8	7802 06 10
6	G1/4	7802 06 13
8	G1/8	7802 08 10
8	G1/4	7802 08 13
10	G1/4	7802 10 13

0669

3/2 manual pneumatic sleeve valves, double female, BSP parallel

ØD	C	
2	M5x0,8	0669 02 19
4	G1/8	0669 04 10
7	G1/4	0669 07 13
10	G3/8	0669 10 17
14	G1/2	0669 14 21
19	G3/4	0669 19 27

0660

3/2 manual pneumatic sleeve valves, double female, NPT

ØD	C	
4	1/8	0660 04 11
7	1/4	0660 07 14
10	3/8	0660 10 18
14	1/2	0660 14 22

0661

3/2 manual pneumatic sleeve valves, male/female, NPT

ØD	C	
4	1/8	0661 04 11
7	1/4	0661 07 14
10	3/8	0661 10 18
14	1/2	0661 14 22

mini-ball valves



7913

3/2, with vent, with push-in connection

ØD	
4	7913 04 00
6	7913 06 00
8	7913 08 00
10	7913 10 00
12	7913 12 00

7914

3/2, with vent, with male BSP parallel thread and push-in connection

ØD	C	
6	G1/8	7914 06 10
8	G1/4	7914 08 13
10	G3/8	7914 10 17
12	G1/2	7914 12 21

7910

2/2, with push-in connection

ØD	
4	7910 04 00
6	7910 06 00
8	7910 08 00
10	7910 10 00
12	7910 12 00

7911

2/2, with male BSP parallel thread and push-in connection

ØD	C	
6	G1/8	7911 06 10
8	G1/4	7911 08 13
10	G3/8	7911 10 17
12	G1/2	7911 12 21

non-return valves, all fluids and stainless steel

4890 one-way, female-female, BSP parallel

ØD	C	
10	G1/8	4890 10 10
10	G1/4	4890 13 13
15	G3/8	4890 17 17
15	G1/2	4890 21 21
20	G3/4	4890 27 27
25	G1"	4890 34 34

4892 one-way, female-male, BSP parallel

ØD	C	
10	G1/8	4892 10 10
10	G1/4	4892 13 13
15	G3/8	4892 17 17
15	G1/2	4892 21 21
20	G3/4	4892 27 27
25	G1"	4892 34 34

4891 one-way, male-female, BSP parallel

ØD	C	
10	G1/8	4891 10 10
10	G1/4	4891 13 13
15	G3/8	4891 17 17
15	G1/2	4891 21 21
20	G3/4	4891 27 27
25	G1"	4891 34 34

4895 one-way, female-female, NPT

ØD	C	
10	1/8	4895 11 11
10	1/4	4895 14 14
15	3/8	4891 18 18
15	1/2	4891 22 22

working pressure: 0,5 to 40 bar
working temperature: -20° to + 180°C

pneumatic and electric sensor fittings

with push-in connection

7818 BSP parallel and metric

ØD	C	
4	M5x0,8	7818 04 19
4	G1/8	7818 04 10
4	G1/4	7818 04 13
4	G3/8	7818 04 17
4	G1/2	7818 04 21

7808 BSP taper

ØD	C	
4	R1/8	7808 04 10
4	R1/4	7808 04 13
4	R3/8	7808 04 17
4	R1/2	7808 04 21

7818-7808 UNF and NPT

ØD	C	
5/32	10-32	7818 04 20
5/32	1/8	7808 04 11
5/32	1/4	7808 04 14
5/32	3/8	7808 04 18
5/32	1/2	7808 04 22

7828 electric, BSP parallel and metric

C	
M5x0,8	7828 00 19
G1/8	7828 00 10
G1/4	7828 00 13
G3/8	7828 00 17
G1/2	7828 00 21

7828 electric, NPT

C	
10-32	7828 00 20
1/8	7828 00 11
1/4	7828 00 14
3/8	7828 00 18
1/2	7828 00 22

with threaded connection

7818 BSP parallel and metric

C	
G1/8	7818 19 10
G1/4	7818 19 13

7808 NPT

C	
1/8	7808 20 11
1/4	7808 20 14
3/8	7808 20 18

Visual identification of different threads

- 7818 04 10 = BSP parallel
- 7808 04 10 = BSP taper
- 7808 04 11 = NPT

legris.com's plus points



Select and download CAD drawings of pneumatic function fittings easily and quickly. An optimised and free service, available to everyone on the Legris Web-site.

www.legris.com



pneumatic function fittings



flow control regulators – metal version

7100-7101

with push-in connection, BSP parallel

ØD	C	Exhaust (A)	Supply (B)
4	G1/8	7100 04 10	7101 04 10
6	G1/8	7100 06 10	7101 06 10
6	G1/4	7100 06 13	7101 06 13
8	G1/8	7100 08 10	7101 08 10
8	G1/4	7100 08 13	7101 08 13
8	G3/8	7100 08 17	7101 08 17
10	G1/4	7100 10 13	
10	G3/8	7100 10 17	
12	G3/8	7100 12 17	
12	G1/2	7100 12 21	
14	G1/2	7100 14 21	

7105

with push-in connection, NPT

ØD	C	Exhaust (A)
5/32	1/8	7105 04 11
1/4	1/8	7105 56 11
1/4	1/4	7105 56 14
3/8	1/4	7105 60 14
3/8	3/8	7105 60 18

7162

with brass compression tube fitting, BSP parallel

ØD	C	Exhaust (A)
8	G1/8	7162 08 10
10	G1/4	7162 10 13
14	G3/8	7162 14 17
18	G1/2	7162 18 21

7180

“miniature” with push-in connection, BSP parallel

ØD	C	Exhaust (A)
4	M5x0,8	7180 04 19
4	G1/8	7180 04 10
6	M5x0,8	7180 06 19
6	G1/8	7180 06 10
8	G1/8	7180 08 10

7190

“miniature” with threaded connection, BSP parallel

C	Exhaust (A)
M5x0,8	7190 19 19
G1/8	7190 10 10

7130

with push-in connection, BSP parallel - recessed adjustment screw

ØD	C	Exhaust (A)
4	M5x0,8	7130 04 19
4	G1/8	7130 04 10
6	M5x0,8	7130 06 19
6	G1/8	7130 06 10
6	G1/4	7130 06 13
8	G1/8	7130 08 10
8	G1/4	7130 08 13
8	G3/8	7130 08 17
10	G1/4	7130 10 13
10	G3/8	7130 10 17
10	G1/2	7130 10 21
12	G3/8	7130 12 17
12	G1/2	7130 12 21

7110-7111

with threaded connection, BSP parallel

C	Exhaust (A)	Supply (B)
G1/8	7110 10 10	7111 10 10
G1/4	7110 13 13	7111 13 13
G3/8	7110 17 17	
G1/2	7110 21 21	

7115

with threaded connection, NPT

C	Exhaust (A)
1/8	7115 11 11
1/4	7115 14 14
3/8	7115 18 18
1/2	7115 22 22

7160

with brass compression tube fitting, BSP parallel

ØD	C	Exhaust (A)
4	G1/8	7160 04 10
6	G1/8	7160 06 10
6	G1/4	7160 06 13
8	G1/8	7160 08 10
8	G1/4	7160 08 13
10	G1/4	7160 10 13
10	G3/8	7160 10 17
10	G1/2	7160 10 21
12	G3/8	7160 12 17
12	G1/2	7160 12 21

7140

with brass compression tube fitting, BSP parallel

C	Exhaust (A)
M5x0,8	7140 19 19
G1/8	7140 10 10
G1/4	7140 13 13
G3/8	7140 17 17
G1/2	7140 21 21

flow control regulators - stainless steel

7810-7812

with threaded fitting, BSP parallel and metric - recessed adjustment screw

C	Exhaust (A)	Supply (B)
M5x0,8	7810 19 19	7812 19 19*
G1/8	7810 10 10	7812 10 10*
G1/4	7810 13 13	7812 13 13*
G3/8	7810 17 17	7812 17 17*
G1/2	7810 21 21	7812 21 21*

* for all fluids

pressure regulator fittings



7300 BSP parallel

ØD	C	
4	G1/8	7300 04 10
6	G1/8	7300 06 10
6	G1/4	7300 06 13
8	G1/8	7300 08 10
8	G1/4	7300 08 13
8	G3/8	7300 08 17
10	G1/4	7300 10 13
10	G3/8	7300 10 17

7305 NPT

ØD	C	
5/32	1/8	7305 04 11
1/4	1/8	7305 56 11
1/4	1/4	7305 56 14
3/8	1/4	7305 60 14

pressure reducer fittings



7318 banjo, BSP parallel with instant fitting

ØD	C	
6	G1/8	7318 06 10
6	G1/4	7318 06 13
8	G1/4	7318 08 13
10	G1/4	7318 10 13
10	G3/8	7318 10 17

7471 banjo, BSP parallel with threaded fitting

C	
G1/8	7471 10 10
G1/4	7471 13 13
G3/8	7471 17 17
G1/2	7471 21 21

7316 in-line, with instant fitting

ØD	
6	7316 06 00
8	7316 08 00
10	7316 10 00

7416 in-line, BSP parallel with threaded fitting

C	
G1/8	7416 10 10
G1/4	7416 13 13
G3/8	7416 17 17
G1/2	7416 21 21

pneumatic soft start fittings

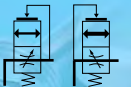

with push-in connection

7860-7870 BSP parallel

ØD	C	FRL	Control valve
8	G1/4	7860 08 13	7870 08 13
10	G1/4	7860 10 13	7870 10 13
10	G3/8	7860 10 17	7870 10 17
12	G3/8	7860 12 17	
12	G1/2	7860 12 21	

with threaded connection

7861-7871 BSP parallel

C	FRL	Control valve
G1/4	7861 13 13	7871 13 13
G3/8	7861 17 17	7871 17 17
G1/2	7861 21 21	

7865-7875 BSP taper

ØD	C	FRL	Control valve
8	R1/8	7865 08 13	7875 08 13

7864-7874 NPT

C	FRL	Control valve
1/4	7864 14 14	7874 14 14
3/8	7864 18 18	7874 18 18

snap connectors



7926 body with LF 3000® connection

ØD	DN	
6	5	7926 05 06
8	5	7926 05 08
10	7,3	7926 07 10

7960 probe with LF 3000® connection

ØD	DN	
6	5	7960 05 06
8	5	7960 05 08
10	7,3	7960 07 10

7921 body with male BSP parallel thread

C	DN	
G1/8	5	7921 05 10
G1/4	5	7921 05 13
G1/4	7,3	7921 07 13
G3/8	7,3	7921 07 17

7961 probe with BSP parallel thread

C	DN	
G1/8	5	7961 05 10
G1/4	5	7961 05 13
G1/4	7,3	7961 07 13
G3/8	7,3	7961 07 17

blocking fittings

"safety"

moving cylinder (active pilot signal)

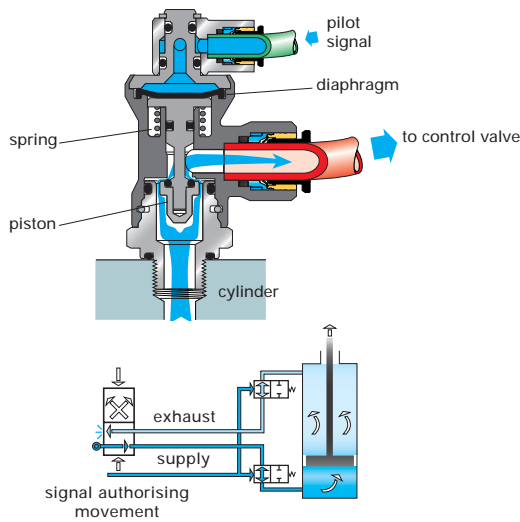

blocked cylinder (pilot signal removed)

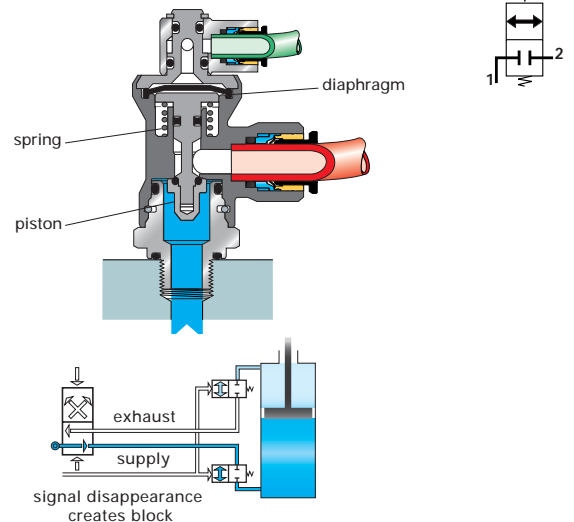

Designed to offer maximum flow capacity Legris blocking fittings **lock the piston** by simultaneously cutting off the supply and exhaust air. Functional locks are more precise and rapid when blocking fittings are located on the cylinder : the volume of air in the pipework no longer needs to be taken into consideration.

installation :

Mounted in **pairs**, blocking fittings are installed directly on the cylinder. As they can be fully swivelled, their use provides excellent flexibility in the design and installation of pneumatic circuits.

specifications :

suitable fluid : compressed air
 working pressure : 1 to 10 bar
 working temperature : - 20° to + 70°C



manually operated and sleeve valves

"safety"

"supply" version

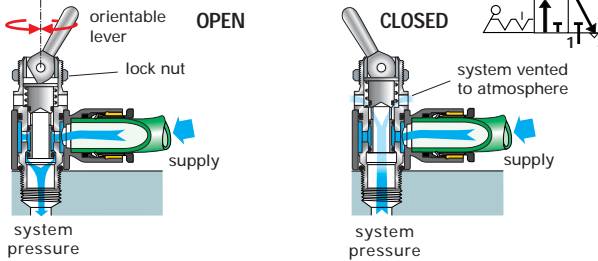

"control" version

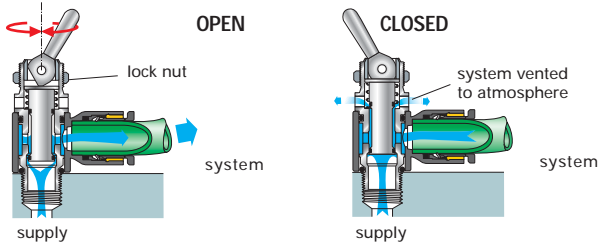

valve open = free flow of air to system

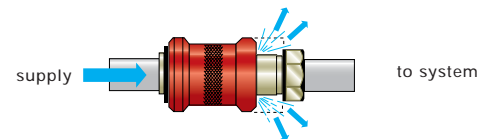

valve closed = supply shut-off, system vented to atmosphere

3/2 and 2/2 manual switch operated vent fittings

Manual switch operated vent fittings can be used whenever the system has to be **frequently vented**. They guarantee immediate isolation of the air line by venting to atmosphere by a simple manual operation of the lever.

Supply is provided (3/2 version):

- on the **instant connection** side (7800-7805)
- on the **threaded** side; when mounted on a **manifold** (e.g. Legris aluminium manifolds). (7801-7806)

specifications :

suitable fluid : compressed air
 maximum working pressure : 10 bar
 working temperature : - 10° to + 80°C

3/2 pneumatic sleeve valves

Pneumatic sleeve valves may be used to **effect isolation of the air line by venting the system to atmosphere**. Their in-line configuration allows compact mounting directly into the pipework.

specifications :

suitable fluid : compressed air
 maximum working pressure : 16 bar
 working temperature : - 10° to + 80°C
 direction of flow: one-way

pressure regulator fittings

"energy efficient"

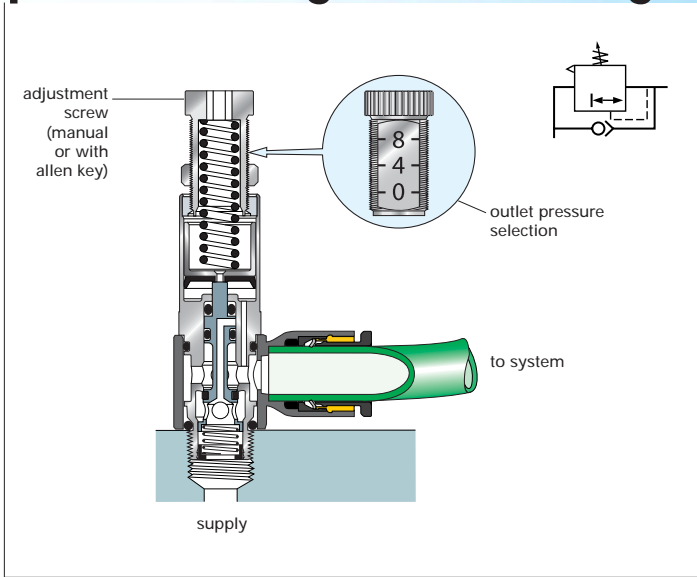

Legris pressure regulator fittings are used to **stabilize at a given value the pressure** applied to pneumatic equipment, whatever the fluctuations of pressure upstream. The pressure outlet is fully controlled by an adjustment screw : to assist pressure selection, the screw is calibrated showing pressure setting levels.

Compact, flow pressure regulators may be mounted:

- downstream of the control valve, for reduced pressure in one direction,
- upstream of the control valve, for reduced pressure in both directions.

specifications :

suitable fluid : compressed air
 working pressure : input pressure : 1 to 16 bar
 regulated pressure : 1 to 8 bar
 working temperature : - 10° to + 70°C

pressure reducer fittings

"energy efficient"

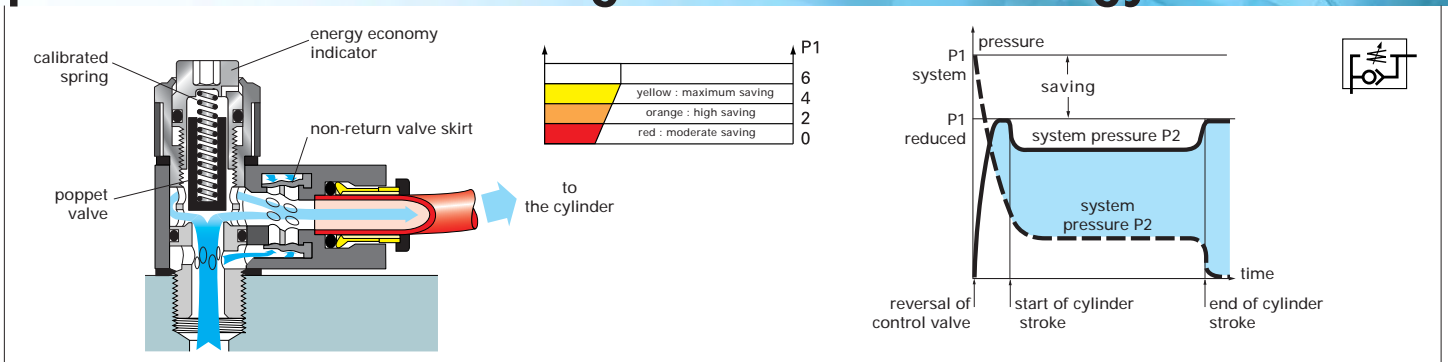

Legris pressure reducer fittings **provide the cylinder with a circuit pressure reduced** to a value determined by manual adjustment, thereby also increasing energy efficiency.

These fittings may be mounted :

- directly to a control valve or terminal block (banjo version),
- on the pipework between the control valve and cylinder (in-line version).

specifications :

suitable fluid : compressed air
 working pressure : 1 to 8 bar
 working temperature : - 15° to + 60°C

pneumatic soft start fittings

"safety"

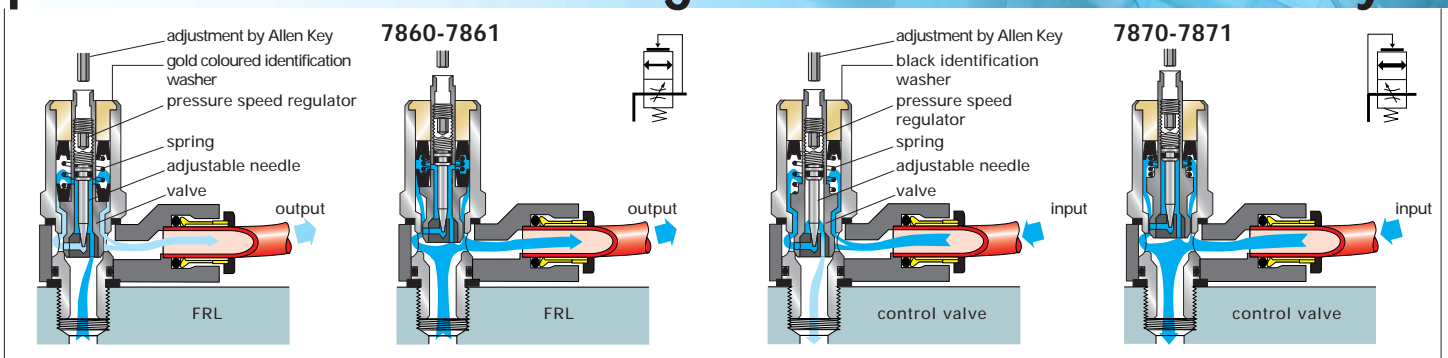

Pneumatic soft start fittings allow air pressure to **gradually increase** on the first cycle only.

They prevent shocks to any pneumatic system : each cylinder thus protected gradually returns to the position it stopped at when the system was vented.

Mounted on the F.R.L. outlet, they protect the whole downstream installation (types 7860-7861/7864/7865).

Mounted on the supply port of the control valve or the

common supply line of several associated valves, they control all designated cylinders (types 7870/7871/7874/7875).

specifications :

suitable fluid : compressed air
 working pressure : 3 to 10 bar
 working temperature : - 15° to + 60°C

non-return valves

"safety"

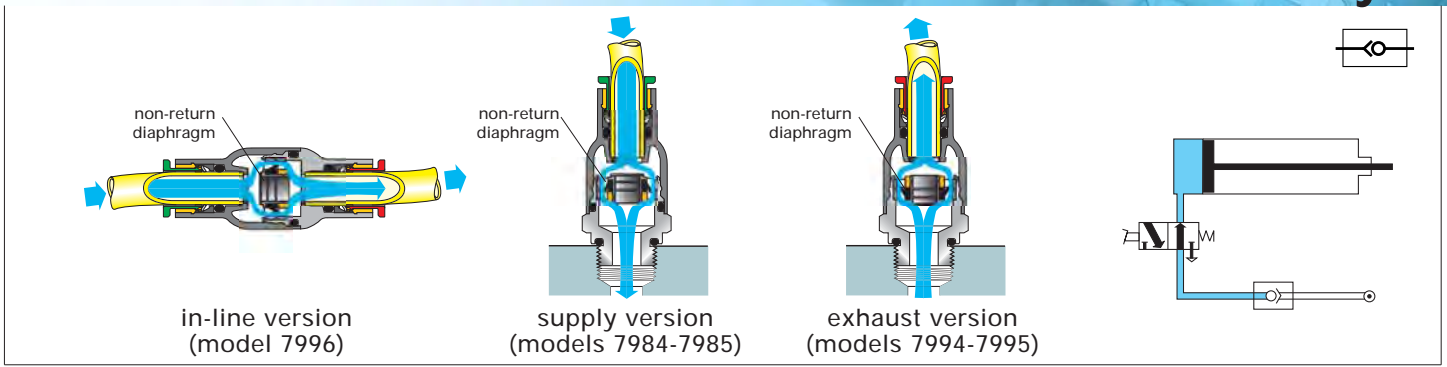

Legris non-return valves allow air to pass in one direction whilst blocking flow in the other direction. The V ring technology ensure positive sealing, even when the fitting is submitted to vibration. These fittings may be mounted upstream of the circuit. Their extreme compactness and light weight make them suitable as a safety item in compressed air circuits.

specifications
 suitable fluid : compressed air
 working pressure : 1 to 10 bar
 working temperature : 0° to + 70°C

pneumatic sensor fittings

"safety"

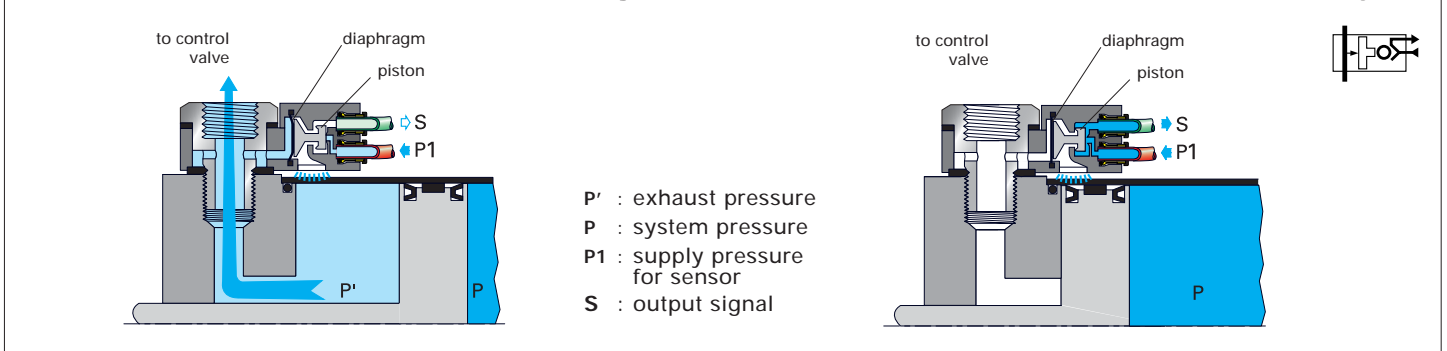

Legris sensor fittings detect pressure drop and are generally used to detect the end-of-travel of a cylinder. They produce an end-of-stroke signal, pneumatic or electric, when the exhaust back pressure in the cylinder disappears. They can be mounted on the cylinder or on the control valve.

specifications :
 suitable fluid : compressed air
 working temperature : -15° to + 60°C
 working pressure : 3-8 bar
 breaking pressure : 0-6 bar
 response time : 3m.s.

symbols of Legris pneumatic function fittings

regulating
air flow



detecting
pressure drop



controlling
air circulation



regulating
pressure by stabilizing at a required value

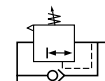

controlling and regulating air flow

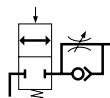

reducing
pressure supply



controlling
the passage of fluid in one direction and non-return in the other



progressive
pressurising of circuits

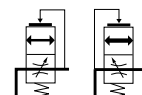

exhausting system
and **controlling** pneumatic circuit supply

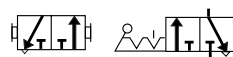

isolate a circuit
without venting the whole installation



flow control regulators

"exhaust" version

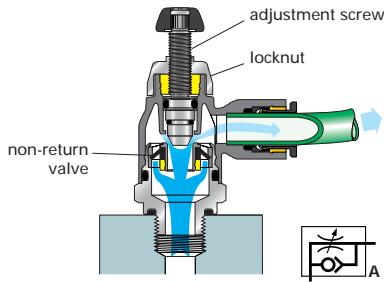

"supply" version

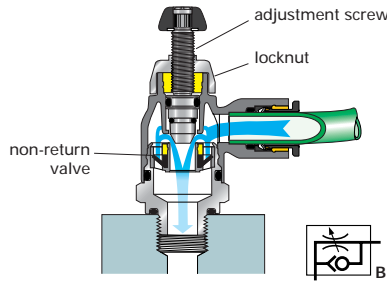

bi-directional version

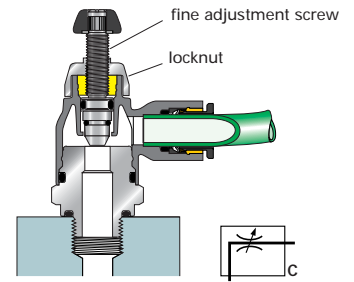

Legris flow control regulators **control the speed of a pneumatic cylinder**. In the one-way version, the exhaust or inlet air flow is controlled by an adjustable restrictor. The inlet or exhaust flow is unrestricted full bore. In a **bi-directional** version, they control air supply in both exhaust and supply flow. Depending upon the model, Legris flow regulators may be fitted on the cylinder or in the compressed air line. However, flow regulation (and therefore cylinder control speed) is more precise and constant when positioned near the cylinder : in this way, it is possible to avoid

the elastic effect of the compressed air contained in the pipework between the control valve and cylinder. Direct mounting of the banjo flow regulator fitting onto the cylinder is therefore the optimum solution.

specifications :

- suitable fluids : compressed air
- working pressure : 1 to 10 bar
- working temperature : 0° to + 70°

mini-ball valves - 2/2 and 3/2 versions

3/2 models with vent

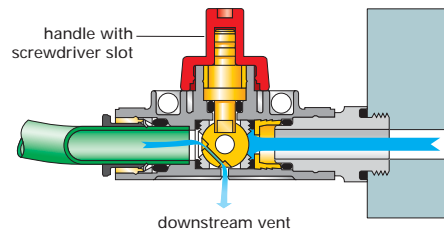
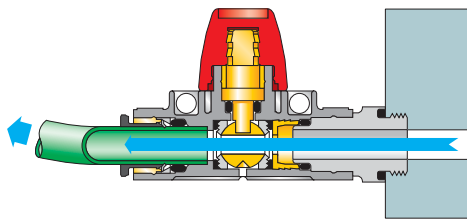

Legris mini-ball valves enable the opening and closing of a pneumatic circuit. Compact and light weight, they are suited to all types of installation. Moreover, thanks to the **3 types of mounting** available, these models are suited to all applications. Their screwdriver slot allows closing and opening, even where access may be difficult. **Full passage**, Legris mini-ball valves offer excellent performance of flow.

technical specifications:

- suitable fluid: compressed air
- maximum pressure: 10 bar
- vacuum capability: vacuum of 755 mm Hg (99% of vacuum)
- working temperature: - 20° to + 80°C

snap connectors

principle of operation

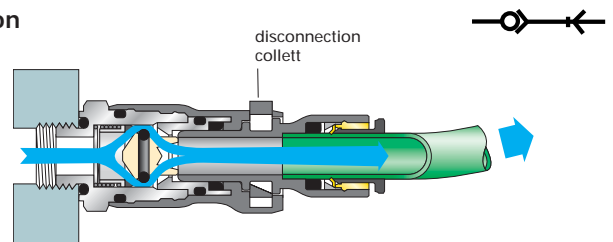
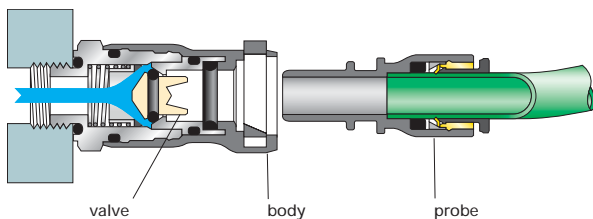

Legris snap connector fittings are used to isolate a circuit without venting the whole installation. They are designed to facilitate frequent connections/disconnections –in complete **safety**. Connection is confirmed by an **audible « click »**.

technical specifications:

- fluid : compressed air
- working temperature: - 20° to + 80°C
- maximum pressure: 10 bar



Connection solutions
for industrial fluids



Our low pressure catalogue is
available upon request.

Parker Legris connectic

products are available from

MARYLAND METRICS

P.O. Box 261 Owings Mills, MD 21117 USA

ph: (410)358-3130 (800)638-1830

fx: (410)358-3142 (800)872-9329

email: sales@mdmetric.com web: <http://mdmetric.com>

RFQ form: <http://mdmetric.com/rfq.htm>