

Ball End Tools



Balldriver® tools are tremendous time savers

High quality machining means:

- Smooth rotational action
- Extended tip life
- Reduced fastener wear

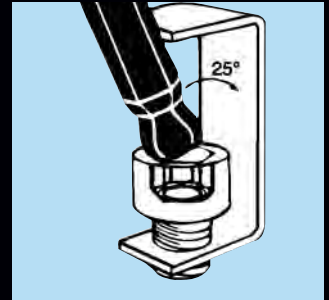

Ball end tools insert into screw head quickly, from up to a 25° angle, even when working in blind locations

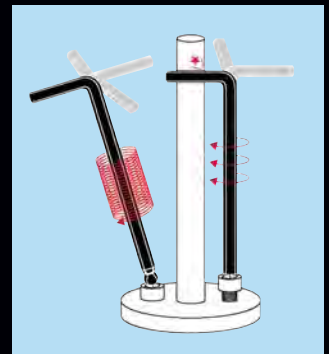

Work efficiently, even near obstructions

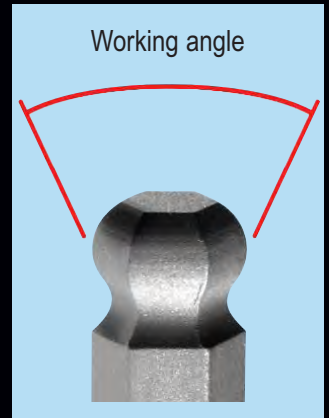

Engineered to deliver the perfect balance between tip strength and working angle

Color Coded

- Inch
- Metric
- Star

PROJENIUM High Torque Steel:

- Up to 20% stronger, with more torque and twice the wear resistance of standard grades of steel.

PROGUARD Corrosion-resistant finish:

- Environmentally safe, provides better tool grip, resists solvents and is 5 times more corrosion resistant than competitor finishes.

Ball End Tool Sets

Ball end Hex Key Sets

Inch Sizes

Inch Sizes													ProHold® Tip	ProGuard™	GoldGuard™	BriteGuard™	Stubby	PCS	Long			Long	Long	Long
.050	1/16	5/64	3/32	7/64	1/8	9/64	5/32	3/16	7/32	1/4	5/16	3/8	7/16	1/2						PART#	MODEL#	LIST EA		
•	•	•	•	•	•	•	•	•	•	•	•	•	•	•		✓				8	10932	BLX8	\$8.05	
•	•	•	•	•	•	•	•	•	•	•	•	•	•	•		✓			12	10936	BLX12	13.90		
•	•	•	•	•	•	•	•	•	•	•	•	•	•	•			✓		12	37936	BLX12G	18.30		
•	•	•	•	•	•	•	•	•	•	•	•	•	•	•	PH	✓		✓	12	16936	BLX12B	17.80		
•	•	•	•	•	•	•	•	•	•	•	•	•	•	•		✓			13	74937	PBLX13	27.55		
•	•	•	•	•	•	•	•	•	•	•	•	•	•	•			✓		13	10937	BLX13	17.85		
•	•	•	•	•	•	•	•	•	•	•	•	•	•	•			✓		13	37937	BLX13G	23.45		
•	•	•	•	•	•	•	•	•	•	•	•	•	•	•				✓	13	16937	BLX13B	22.80		
•	•	•	•	•	•	•	•	•	•	•	•	•	•	•		✓			13	16537	SBLX13	21.90		
•	•	•	•	•	•	•	•	•	•	•	•	•	•	•				✓	13	16737	SBLX13B	28.99		
•	•	•	•	•	•	•	•	•	•	•	•	•	•	•		✓			13	in metal box		10933	MBLX13	40.70
•	•	•	•	•	•	•	•	•	•	•	•	•	•	•	PH	✓			15	in vinyl roll up pouch		10935	BLX15	43.70
•	•	•	•	•	•	•	•	•	•	•	•	•	•	•		✓			10	74938	PBLX10	17.20		
•	•	•	•	•	•	•	•	•	•	•	•	•	•	•		✓			10	10938	BLX10	11.15		
•	•	•	•	•	•	•	•	•	•	•	•	•	•	•			✓		10	37938	BLX10G	14.65		
•	•	•	•	•	•	•	•	•	•	•	•	•	•	•				✓	10	16938	BLX10B	14.25		
•	•	•	•	•	•	•	•	•	•	•	•	•	•	•				✓	10	16538	SBLX10	13.70		
•	•	•	•	•	•	•	•	•	•	•	•	•	•	•				✓	10	16738	SBLX10B	18.10		
•	•	•	•	•	•	•	•	•	•	•	•	•	•	•		✓			7	10945	BLX7	7.55		

Metric Sizes

Metric Sizes																		PCS	Extra Long			Long					
1.27	1.5	2.0	2.5	3.0	3.5	4.0	4.5	5.0	5.5	6.0	7.0	8.0	9.0	10.0						PART#	MODEL#	LIST EA	PART#	MODEL#	LIST EA		
•	•	•	•	•	•	•	•	•	•	•	•	•	•	•		✓			15				10995	BLX15M	\$24.35		
•	•	•	•	•	•	•	•	•	•	•	•	•	•	•			✓		15				38095	BLX15MG	31.90		
•	•	•	•	•	•	•	•	•	•	•	•	•	•	•				✓	15	17095	BLX15MB	\$31.00					
•	•	•	•	•	•	•	•	•	•	•	•	•	•	•			✓		6				10946	BLX6M	6.60		
•	•	•	•	•	•	•	•	•	•	•	•	•	•	•			✓		6				38046	BLX6MG	8.65		
•	•	•	•	•	•	•	•	•	•	•	•	•	•	•	PH	✓		✓	6	17046	BLX6MB	8.40					
•	•	•	•	•	•	•	•	•	•	•	•	•	•	•		✓			7				74992	PBLX7M	13.65		
•	•	•	•	•	•	•	•	•	•	•	•	•	•	•		✓			7				10992	BLX7M	8.80		
•	•	•	•	•	•	•	•	•	•	•	•	•	•	•				✓	7				16592	SBLX7M	10.80		
•	•	•	•	•	•	•	•	•	•	•	•	•	•	•				✓	7	16792	SBLX7MB	14.40					
•	•	•	•	•	•	•	•	•	•	•	•	•	•	•			✓		7				38092	BLX7MG	11.60		
•	•	•	•	•	•	•	•	•	•	•	•	•	•	•	PH	✓		✓	7	17092	BLX7MB	11.30					
•	•	•	•	•	•	•	•	•	•	•	•	•	•	•		✓			9				74999	PBLX9M	22.35		
•	•	•	•	•	•	•	•	•	•	•	•	•	•	•		✓			9				10999	BLX9M	14.50		
•	•	•	•	•	•	•	•	•	•	•	•	•	•	•				✓	9				16599	SBLX9M	17.80		
•	•	•	•	•	•	•	•	•	•	•	•	•	•	•				✓	9	16799	SBLX9MB	23.50					
•	•	•	•	•	•	•	•	•	•	•	•	•	•	•			✓		9				38099	BLX9MG	19.00		
•	•	•	•	•	•	•	•	•	•	•	•	•	•	•				✓	9	17099	BLX9MB	18.50					
•	•	•	•	•	•	•	•	•	•	•	•	•	•	•		✓			13				in metal box		10989	MBLX13M	\$78.15





























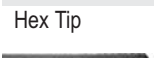



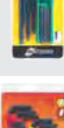

Ball End Tool Sets

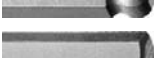
Double Packs and Multi Packs

Combinations of our most popular sets









- Two sets per package
- Tip selections include Balldriver®, Hex, Star and ProHold® tips

TIPS	INCH SIZE	METRIC SIZE	STAR SIZE	TOOLS	PART#	MODEL #	LIST EA
   		1.5 - 10mm Ball end hex key set		16pcs	14187	BLF16	\$20.90
 		.050 - 3/8 Ball end hex key set		22pcs	14189	BLF22	23.35
 		5/64 - 1/4 Hex tip GorillaGrip® fold up .050 - 3/8 Ball end hex key set		22pcs	20199	BLX22	30.45
 		.050 - 5/16 Ball end hex key set		21pcs	20196	BLX21	26.85
 		.050 - 3/8 Ball end GoldGuard™ hex key set		22pcs	20899	BLX22G <i>(with GoldGuard™ finish)</i>	40.00
 		.050 - 3/8 Ball end BriteGuard™ hex key set		22pcs	20399	BLX22GB <i>(with BriteGuard™/GoldGuard™ finish)</i>	41.50
 		.050 - 3/8 Stubby Ball end hex key set		22pcs	20599	SBLX22	37.50
 		.050 - 3/8 Ball end hex key set with ProHold® tip		22pcs	20499	PBLX22	46.95
 		1.5 - 10mm Ball end hex key set	T6 - T25 GorillaGrip® fold up	17pcs	14126	BLF17S	26.60
 		1.5 - 10mm Ball end hex key set	T9 - T40 GorillaGrip® fold up	17pcs	14128	BLF17	26.85
Hex Tip 		.050 - 3/8 Hex key Set		22pcs	22199	HLX22	18.90

Triple Packs

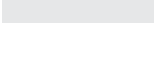
Balldriver®, Hex & Star Tips

Three tool sets per package — two hex key sets and one GorillaGrip® Fold Up

TIPS	INCH SIZE	METRIC SIZE	STAR SIZE	TOOLS	PART#	MODEL #	LIST EA
  		.050 - 3/8 Ball end hex key set		34pcs	14130	BLF34	\$39.85
 		5/64 - 5/32 and 1.5 - 5mm hex GorillaGrip® fold up .050 - 3/8 Ball end hex key set		30pcs	14132	BLF30TS	43.65
 		.050 - 3/8 Ball end hex key set	T9 - T40 Star GorillaGrip® fold up	30pcs	14138	BLF30T	43.89

Ball End Tool Sets

T-Handle Sets



Inch Sizes



SIZE	PCS	PART#	MODEL #	LIST EA
3/32 – 3/8	10	13138	BTX10*	\$53.50
5/32 – 3/8	6	13146	BTX60	39.65
3/32 – 3/8	10	13190	BTX10/S†*	57.00

Metric Sizes

SIZE	PCS	PART#	MODEL #	LIST EA
4 – 10mm	5	13148	BTX50M	\$34.05
2 – 10mm	8	13187	BTX80M*	43.85
2 – 10mm	8	13189	BTX80M/S†*	47.35

*The 3/32, 7/64, 1/8, and 9/64 inch blades, and the 2, 2.5 and 3mm blades are straight hex blades to prevent breakage.

† With stand

GorillaGrip® Sets



Inch Sizes



SIZE	PCS	PART#	MODEL #	LIST EA
3/16 – 3/8	5	12894	BF5	\$14.10

Metric Sizes

SIZE	PCS	PART#	MODEL #	LIST EA
5 – 10mm	5	12897	BF5M	\$14.10

Power Bit Sets

Inch Sizes



SIZE	PCS	PART#	MODEL #	LIST EA
5/64 – 1/2	12	10836	BHX12	\$35.10

Metric Sizes

SIZE	PCS	PART#	MODEL #	LIST EA
2 – 12mm	9	10899	BHX9M	\$30.18

BallStar™ Screwdriver Sets



SIZE	PCS	PART#	MODEL #	LIST EA
T9 – T40	8	13532	STX8	\$61.05
T6 – T15	6	13546	STX6	41.15

Screwdriver Sets

Inch Sizes



SIZE	PCS	PART#	MODEL #	LIST EA
.050 – 5/32	8	10632	BSX8S	\$22.25
7/64 – 5/16	8	10633	BSX8	36.10
.050 – 3/8	13	10637	BSX13	53.55
5/64 – 3/16	7	10645	BSX7	22.05
5/64 – 3/8	11	10737	BSX11L	58.85

Metric Sizes

SIZE	PCS	PART#	MODEL #	LIST EA
1.5 – 5mm	6	10686	BSX6M	\$19.20
1.27 – 5mm	7	10687	BSX7M	21.40
1.5 – 10mm	9	10699	BSX9M	42.20
2 – 10mm	8	10733	BSX8ML	48.15

Insert Bit Sets

Inch Sizes



SIZE	PCS	PART#	MODEL #	LIST EA
5/64 – 1/2	12	11036	BIX12	\$29.49

Metric Sizes

SIZE	PCS	PART#	MODEL #	LIST EA
2 – 12mm	9	11099	BIX9M	\$25.95

BallStar™ Key Sets



SIZE	PCS	PART#	MODEL #	LIST EA
T6 – T25	8	11331	LTX8S	\$40.25
T9 – T40	8	11332	LTX8	45.30
T6 – T15	6	11346	LTX6	29.10

